

# WLVDE-251 Wind-Driven Rain Louver Vertical Dual Blade

## Application

FLOWTECH's WLVDE-251 Wind-Driven Rain Louver Vertical Dual Blade is specially designed for high ability to water-penetration. The WLVDE-251 is an **AMCA CERTIFIED LOUVER**, it can effectively block water from penetrating through spaces between blades due to the good design of drainable blade shape, therefore secure the indoor possessions.

## Standard Construction

**Frame:** Extruded 6063-T5 aluminum of 2.0 mm thickness

**Blade (Front):** Extruded 6063-T5 of 1.5 mm thickness, Positioned on approximately 82 mm blade spacing

**Blade (Rear):** Extruded 6063-T5 of 1.5 mm thickness, Positioned on approximately 25 mm blade spacing

**Minimum Size:** 12 in. (305 mm) W X 12 in. (305 mm) H

**Maximum Size:** 60 in. (1524 mm) W X 96 in. (2438 mm) H

## Options

- A variety of bird and insect screens
- Filter rack
- Flanged Frame
- A variety of surface finish
- Sill pan

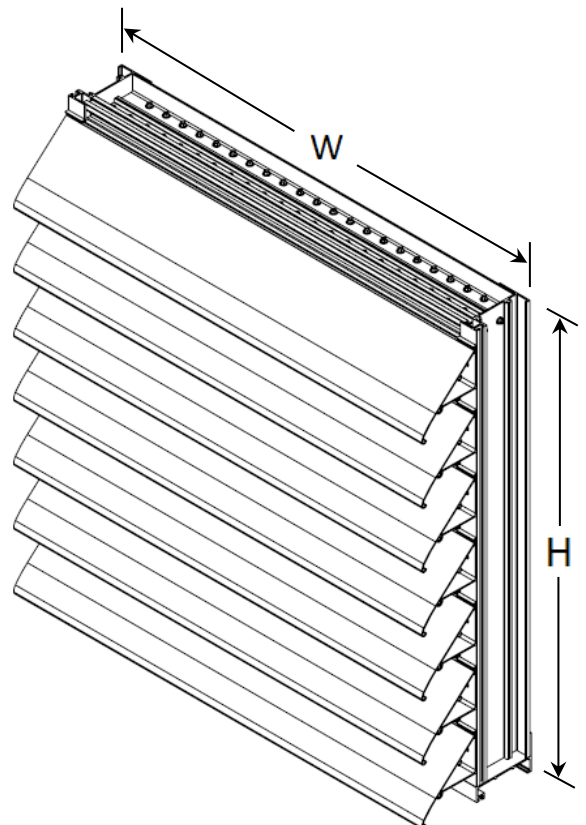
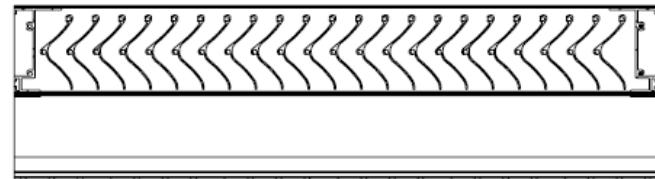
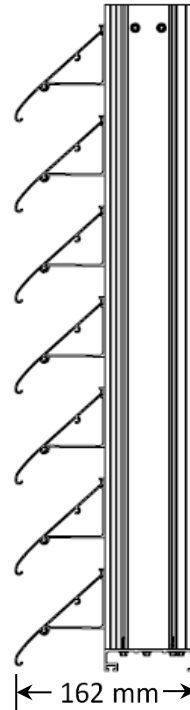

## Wind-Driven Rain Performance

76 mm/hr Rainfall & 13 m/s Wind Velocity					203 mm/hr Rainfall & 22 m/s Wind Velocity				
Core Velocity		Volume Air Flow Rate	Water Penetration		Core Velocity		Volume Air Flow Rate	Water Penetration	
fpm	m/s	m <sup>3</sup> /s	Class	Effective	fpm	m/s	m <sup>3</sup> /s	Class	Effective
0	0	0	A	100	0	0	0	A	100
98	0.5	0.5	A	100	98	0.5	0.5	A	100
197	1.0	1.0	A	100	197	1.0	1.0	A	100
295	1.5	1.5	A	100	295	1.5	1.5	A	100
394	2.0	2.0	A	100	394	2.0	2.0	A	100
492	2.5	2.5	A	99.7	492	2.5	2.5	A	99.9
591	3.0	3.0	A	99.6	591	3.0	3.0	A	99.8
689	3.5	3.5	A	99.0	689	3.5	3.5	A	99.3
787	4.0	4.0	B	97.6	787	4.0	4.0	B	98.6
886	4.5	4.5	B	95.7	886	4.5	4.5	B	98.1
984	5.0	5.0	C	94.9	984	5.0	5.0	B	96.6

\*WVLE-251 Discharge Loss Coefficient Class (Intake) = 3

WLVE-251 Discharge Loss Coefficient Class (Exhaust) = 3

Discharge Loss Coefficient Classifications	
Class	Discharge Loss Coefficient
1	0.4 and Above
2	0.3 to 0.399
3	0.2 to 0.299
4	0.199 and Below

Wind-driven Rain Penetration Classifications	
Class	Effectiveness
A	1 to 0.99
B	0.989 to 0.95
C	0.949 to 0.80
D	Below 0.80



FLOWTECH Co. Ltd. certifies that the WLVE-251 shown hereon is licensed to bear the AMCA Seal. The ratings shown are based on tests and procedures performed in accordance with AMCA Publication 511 and comply with the requirements of the AMCA Certified Ratings Program. The AMCA Certified Ratings Seal applies to Water Penetration, Wind-Driven Rain, and Air Performance ratings.

**Air Performance**

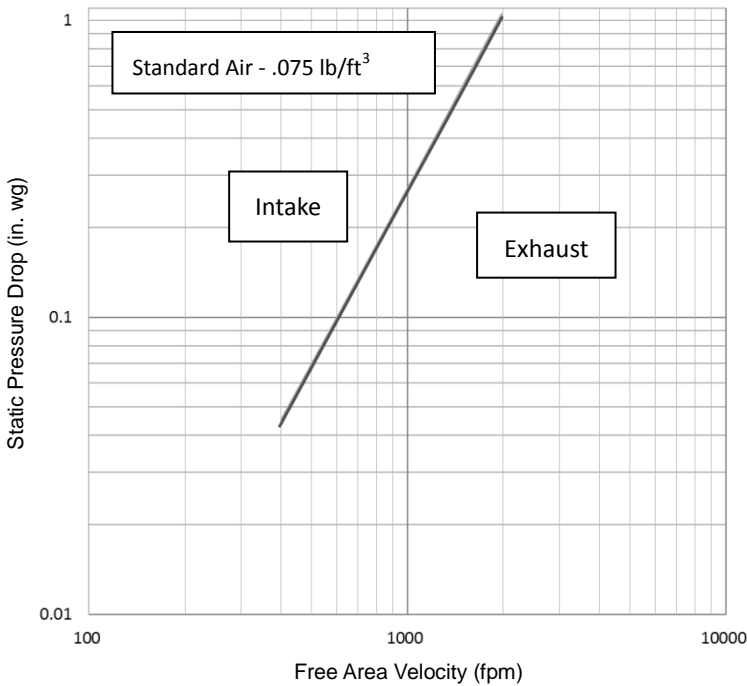

1. Tested in accordance with ANSI/AMCA 500-L, Figure 5.5
2. Test sample size is 48 in. x 48 in.
3. Data are based on intake and exhaust performance.

**Water Penetration**

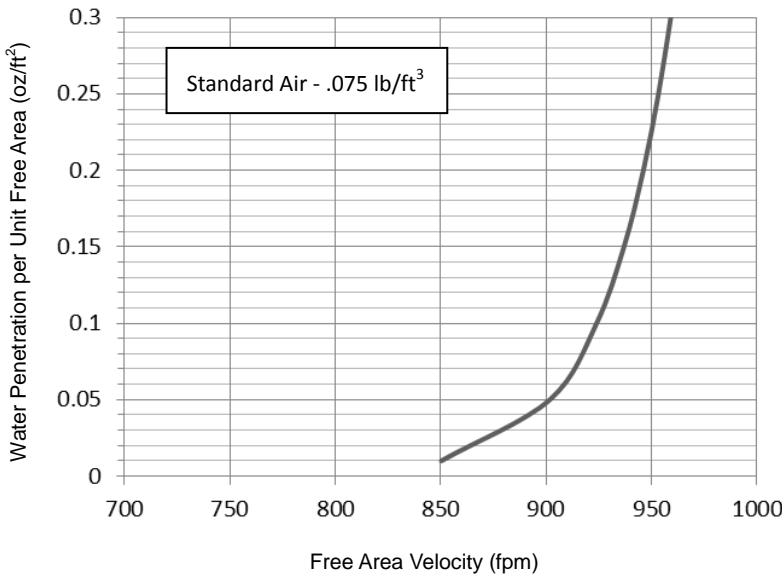

1. Tested in accordance with ANSI/AMCA 500-L, Figure 5.6
2. Test sample size is 48 in. x 48 in.
3. The beginning point of water penetration is 850.9 fpm.
4. Test Duration 15 min.



FLOWTECH Co. Ltd. certifies that the WLVDE-251 shown hereon is licensed to bear the AMCA Seal. The ratings shown are based on tests and procedures performed in accordance with AMCA Publication 511 and comply with the requirements of the AMCA Certified Ratings Program. The AMCA Certified Ratings Seal applies to Water Penetration, Wind-Driven Rain, and Air Performance ratings.

### Free Area Chart (sq. m.)

Height (m)	Width (m)												
	0.305	0.457	0.610	0.762	0.914	0.991	1.067	1.143	<b>1.219</b>	1.295	1.372	1.448	1.524
0.305	0.026	0.042	0.058	0.073	0.089	0.097	0.105	0.113	0.121	0.128	0.136	0.144	0.152
0.610	0.063	0.101	0.138	0.176	0.214	0.232	0.251	0.270	0.289	0.308	0.327	0.345	0.364
0.762	0.087	0.140	0.192	0.244	0.297	0.323	0.349	0.375	0.401	0.427	0.453	0.480	0.506
0.914	0.112	0.179	0.246	0.313	0.380	0.413	0.447	0.480	0.513	0.547	0.580	0.614	0.647
1.067	0.136	0.218	0.299	0.381	0.463	0.503	0.544	0.585	0.626	0.666	0.707	0.748	0.789
<b>1.219</b>	0.161	0.257	0.353	0.449	0.546	0.594	0.642	0.690	<b>0.738</b>	0.786	0.834	0.882	0.930
1.524	0.210	0.335	0.461	0.586	0.712	0.774	0.837	0.900	0.962	1.025	1.088	1.151	1.213
1.676	0.222	0.355	0.487	0.620	0.753	0.819	0.886	0.952	1.019	1.085	1.151	1.218	1.284
1.829	0.246	0.394	0.541	0.689	0.836	0.910	0.983	1.057	1.131	1.204	1.278	1.352	1.426
1.981	0.271	0.433	0.595	0.757	0.919	1.000	1.081	1.162	1.243	1.324	1.405	1.486	1.567
2.134	0.295	0.472	0.649	0.825	1.002	1.090	1.179	1.267	1.355	1.444	1.532	1.620	1.709
2.286	0.320	0.511	0.702	0.894	1.085	1.181	1.276	1.372	1.468	1.563	1.659	1.754	1.850
2.438	0.344	0.550	0.756	0.962	1.168	1.271	1.374	1.477	1.580	1.683	1.786	1.889	1.992

### Core Area Chart (sq. m.)

Height (m)	Width (m)												
	0.305	0.457	0.610	0.762	0.914	0.991	1.067	1.143	<b>1.219</b>	1.295	1.372	1.448	1.524
0.305	0.066	0.106	0.145	0.185	0.225	0.244	0.264	0.284	0.304	0.324	0.343	0.363	0.383
0.610	0.144	0.230	0.316	0.402	0.488	0.531	0.574	0.617	0.660	0.703	0.746	0.789	0.832
0.762	0.183	0.292	0.401	0.511	0.620	0.674	0.729	0.784	0.838	0.893	0.948	1.002	1.057
0.914	0.222	0.354	0.487	0.619	0.752	0.818	0.884	0.950	1.017	1.083	1.149	1.215	1.281
1.067	0.260	0.416	0.572	0.728	0.883	0.961	1.039	1.117	1.195	1.273	1.350	1.428	1.506
<b>1.219</b>	0.299	0.478	0.657	0.836	1.015	1.104	1.194	1.283	<b>1.373</b>	1.462	1.552	1.641	1.731
1.524	0.377	0.602	0.828	1.053	1.278	1.391	1.504	1.617	1.729	1.842	1.955	2.067	2.180
1.676	0.416	0.664	0.913	1.162	1.410	1.534	1.659	1.783	1.907	2.032	2.156	2.280	2.405
1.829	0.455	0.726	0.998	1.270	1.542	1.678	1.814	1.950	2.086	2.222	2.357	2.493	2.629
1.981	0.493	0.788	1.083	1.379	1.674	1.821	1.969	2.116	2.264	2.411	2.559	2.706	2.854
2.134	0.532	0.850	1.169	1.487	1.805	1.965	2.124	2.283	2.442	2.601	2.760	2.919	3.079
2.286	0.571	0.913	1.254	1.596	1.937	2.108	2.279	2.449	2.620	2.791	2.962	3.132	3.303
2.438	0.610	0.975	1.339	1.704	2.069	2.251	2.434	2.616	2.798	2.981	3.163	3.345	3.528

**Maximum Size Information**

Single Section

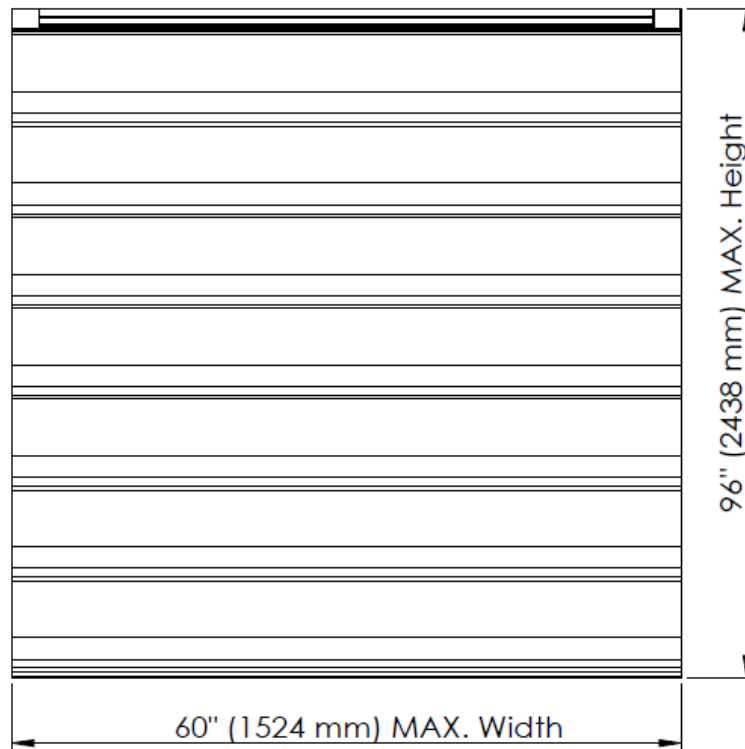

Multiple Section / Mullion

